

Service Manual

CHIGO DC Inverter Split type A/C

Remark: there can be a little difference between the unit you purchase and the universal version.

1.1 Check the user's power supply (kilowatt-meter capacity, wire diameter, electric leakage protection switch, ground wire and voltage)

Check the power supply	Use the multimeter to measure the power voltage, which shall be within +/-10% of the rated voltage.
	Use special line for the power supply of air conditioners, and ensuring that the capacity of entire supply line (branch line, power line, kilowatt-meter, air switch, etc) is higher than the maximum rated current of air conditioner.
	The power configuration and cable distribution must meet the local requirements for electrical safety.
	Advise the user to apply special air switch, electric leakage protector and other necessary protection devices for air conditioners. Their capacity shall meet the needs of air conditioner. For the line with fuse, it is prohibited to use copper wire to replace the fuse.

1.2 Execution of Installation

Table: Standard of piping torque:

1. Nut torque of connecting pipe (R410a)

Outer diameter of copper pipe		Torque
mm	inch	Kg.f/m
6.35	1/4	1.8
9.52	3/8	4.2
12.7	1/2	5.5
15.88	5/8	6.6
19.05	3/4	6.6

Inspection before machine testing	Check if the internal wires of the unit are connected. It needs to be noted particularly that the wires shall be connected correspondingly; the grounding shall be reliable; and all the naked wires shall be pressed tightly. When the power was off, the insulating electric-resistance of the null line, the live wire and the ground wire of the plug shall be more than 2 megohm.
	Inspect whether the indoor and outdoor units are installed firmly.
	Make sure that all people or objectives are away from the machine, do check it's safe before turn the power on.

1.3 Introduction of usage and maintenance knowledge

Test of testing machine	Introduce the method of disassembling and cleaning the filter net (replacing the air filter) to the user, and instruct them to operate until they are skillful. The outdoor unit shall be ventilated, so as to prevent sundries from blocking the condenser and influencing the heat dissipation. Users can inspect and clean the condenser and remove sundries when they can guarantee their safety, or they shall ask professionals for help.
-------------------------	---

2. Wiring diagrams (outdoor and indoor, zoom in when reading please)

9K, 12K Btu indoor unit

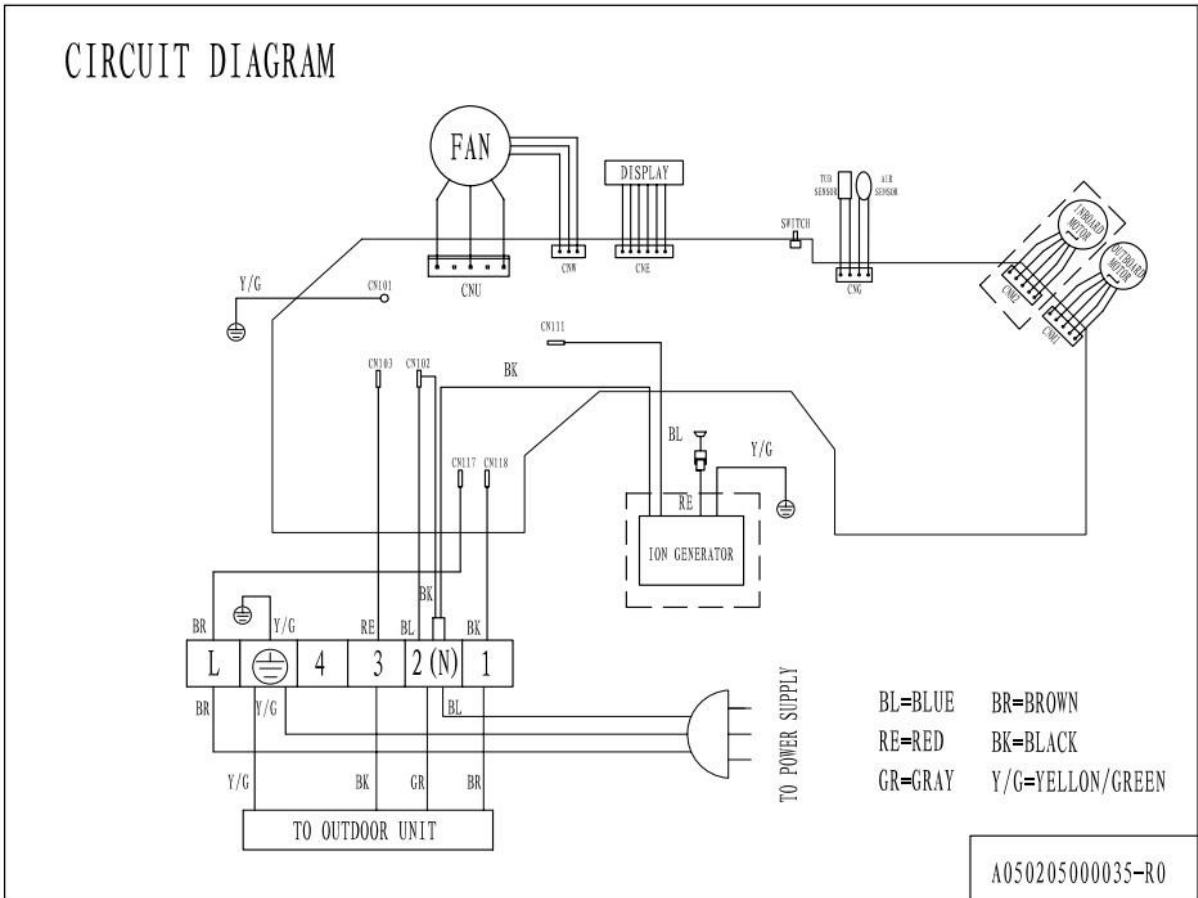

9K, 12K Btu outdoor unit

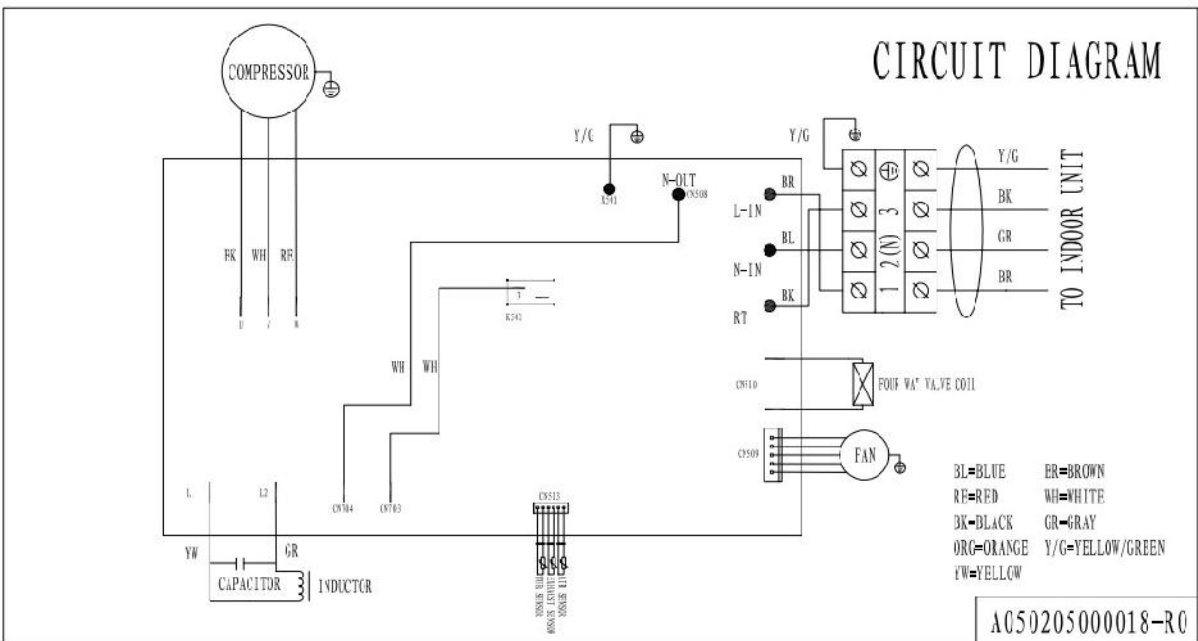

3. The specifications on common software functions for inverter AC

3.1 Universal basic requirement

The power voltage's sphere of application: Alternating current 50/60Hz are compatible, to permit the voltage wave range: 170V ~ 264V

The ambient temperature and humidity of using the PCB: $-20^{\circ}\text{C} \sim 85^{\circ}\text{C}$, $\varphi=30\% \sim 95\%$;

3.2. Software function

3.2.1 The symbol and wind speed's definitions

(a) The symbol definition

Ts: the setting temp.

Tr: the indoor temp.

Tp: the indoor coil pipe temp.

(b) The wind speed definition

The indoor fan (PG motor) wind speed definition. Please refer to the following **form 2-1**.

Form 2-1

model	mode	Super high winds	High winds	Mid winds	Low winds	Slightly winds
Any	cooling	FS5	FS4	FS3	FS2	FS1
model	heating	FS10	FS9	FS8	FS7	FS6

NOTE : (1) The FS1 ~ FS10 are programmable dates, and they are in the EEPROM;

(2) The motor rotate-speed should refer to the motor parameter, if the indoor motor uses the tapped control.

3.2.2 basic mode

The automatic mode

1. the models with the universal remote controller

(1) the setting temperature is 25°C , and it is unadjustable.

(2) If press the "emergency switch" button on standby or use the remote controller to set the automatic mode, the air-conditioner will enter the automatic operating mode, and its default setting temperature is 25°C .

(3) when enter the automatic mode, the system will decide the corresponding running mode according to the indoor ambient temperature, please refer to **form 2-3**:

Form 2-3

Indoor temp.	$\text{Tr} < 21$	$21 \leq \text{Tr} < 26$	$26 \leq \text{Tr}$
Running mode	heating	ventilation	cooling

(4) once the running mode is confirmed:

a) the mode doesn't automatically change any more with the indoor temperature's vary.

b) when the user makes remote controller or emergency switch turn off the unit, and enter the automatic mode again, the indoor software will judge the running mode once more.

c) if different modes switching brings about the compressor's stop, but 3 min protect is still effective.

(5) working condition of the compressor:it is determined by the entering running mode.

(6) working condition of the four-way valve:it is determined by the entering running mode.

(7) working condition of the outdoor fan:it is determined by the entering running mode.

2. meanwhile the indoor electronic control has the function that discriminates CHIGO Two kinds of universal remote controller yards, after receiving remote controller signal, the indoor electronic control can confirm and adopt the relevant function according to identification marks in remote control signal.

3.2.3 Cooling mode(The outdoor maximum operation temperature in cooling: 43°C)

1. the setting temperature's range:16 -32

2. working condition of the compressor:

In the cooling mode, the controller carries out the Fuzzy reasoning according to the deviation of current indoor environment temperature and setting temperature, and indoor temperature's vary rate and so on. Thus it can decide the compressor's running condition and indoor fan's wind speed in order to achieve use requirement.

3. the compressor's starting frequency, running frequency's going up and down, running condition and the outdoor fan's working condition refer to the instructions of outdoor software function.

4. the processing of turning on and turning off the unit:

In cooling mode, the following chart 2-1 is the compressor's processing curve of turning on and turning off the unit:

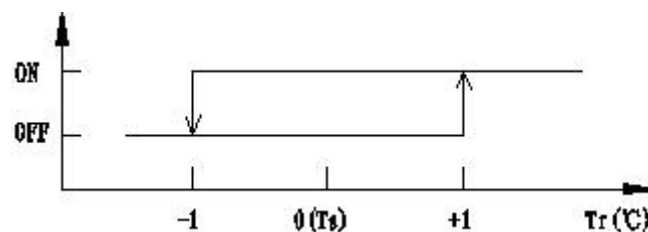

Chart 2-1

5. working condition of the indoor fan motor:

The indoor fan's speed can be chosen in automatic, high, mid, low condition; and runs at super high wind, high wind, mid wind or low wind speed.

when choose the automatic wind,the indoor fan's work is shown as the following chart 2-2:

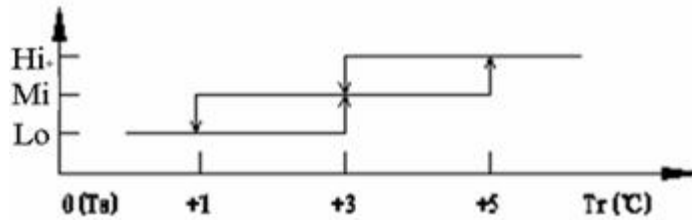

Chart 2-2

6. Blow remain cold function: when turning off the unit with the remote controller or emergency switch, the indoor fan is at low wind speed, and be turned off after time lag 30 seconds; the indoor wind swing times lag 35 seconds and be turned off, thus that can blowout the remaining cold energy and ensure the indoor unit dry.

7. working condition of the four-way valve: the four-way valve is closed all the time in cooling mode.

8. working condition of the external air flap in cooling:

(1) confirm the air flap's full open position is Pch1, and the full closed position is Pch2.

(a) when the unit is electrified, firstly, the air flap opens to Pch1 position and then back to Pch2 position.

(b) turning on the unit, firstly, the air flap opens to Pch1 position and then back to Pch2 position.

(c) turning off the unit, firstly, the air flap opens to Pch1 position and then normally runs.

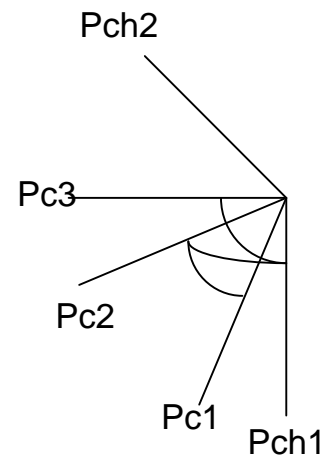

Chart 2-3

(2) working condition of the fixed wind in cooling:

(a) if the unit is electrified at the first, the condition is set fixed wind when turning on the unit, and firstly, the air flap opened to Pch1, and then stop to Pc2 position of the fixed wind.

(b) in the swing wind or natural wind, if it is transformed to fixed wind, the air flap will directly stop the current running position, and memories this position; next time the user starts the unit at the fixed wind, the wind pendulum is in last memory position.

(3) operating condition of the swing wind in cooling:

(a) when it is swing wind, the air flap's starting point position is Pc1.

(b) the air flap firstly back to full open position Pch1 and then work at the swing wind way from the fixed wind or natural wind to swing wind.

(c) The air flap swings to go back and forth between Pc1 and Pc3 in swing wind condition.

(4) the natural wind is achieved when the wind pendulum swings two circles and stops 30 seconds in the swing wind condition.

The definition of the external air flap's position is showed below table 2-4:

Table 2-4

Full open	Full close	Fixed wind	Starting point to swing wind	Destination to swing wind
Pc1	Pch2	Pc2	Pc1	Pc3

NOTE: Pch1.Pch2.Pc1~Pc3 are programmable dates that be stored in EEPROM.

9. when the units operate in cooling mode, the units have the relevant outdoor ambient temperature's limiting and protection, the protection to the indoor coil pipe preventing frostbite, the outdoor exhaust temperature overheating protection, overcurrent protection, low-voltage protection, the compressor overheating protection, indoor fan fault protection, sensor fault protection, system fault protection, IPM fault protection, communications fault protection, 3 minutes time lag protection of the compressor and so on.

Dehumidification mode

1. the range to the setting temperature: it is tolerated 25 and is unadjustable.

2. working condition of the compressor:

the compressor chooses the relevant running way according to the indoor temperature in the dehumidification mode.

3. working condition of outdoor fan: the outdoor is the synchronous operation with compressor in the dehumidification mode.

4. working condition of indoor fan: the indoor fan's wind speed is FS11 and is not adjustable in the dehumidification mode (FS11 is programmable date, and stored in the indoor EEPROM) .

5. working condition of the four-way valve: the four-way valve is closed all the time in the dehumidification mode.

6. working condition of the external air flap: the external air flap is in the anti condensation position (P1) and can be not adjusted in the dehumidification mode.

NOTE:P1 is programmable date, and stored in the indoor EEPROM.

7. there are not the TURBO/ECONOMY functions in the dehumidification mode.

8. the indoor heat exchanger anti freezing function is still effective in the dehumidification mode.

9. when turn off the unit in the dehumidification mode, the indoor fan and the wind pendulum's running are the same as that in the cooling mode.

3.2.4 Heating mode(the outdoor minimum operation temperature in heating: -10)

1. the range to the setting temperature: 16 -32

2. working condition of the compressor:

In the heating mode, the controller carries out the Fuzzy reasoning according to the deviation of current

indoor environment temperature and setting temperature ,and indoor temperature's vary rate and so on. Thus it can decide the compressor's running condition and indoor fan's wind speed in order to achieve use requirement.

3. the compressor's starting frequency, running frequency's going up and down, running condition refer to the instructions of outdoor software function.

4. the processing of turning on and turning off the unit:

In the heating mode, indoor ambient temperature increases 3 temperature compensation. that is: when ΔT is less than 2 , the compressor starts ($\Delta T= Tr-Ts$);when ΔT is greater than or equal to 4 , the compressor is turned off.

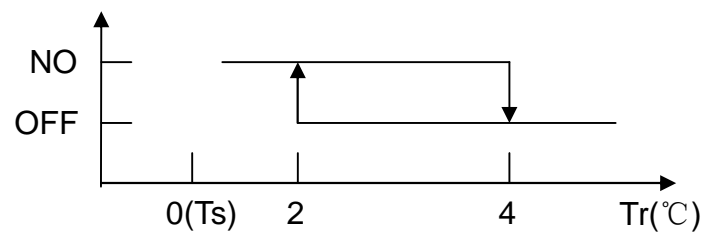

Chart 2-4

5. working condition of indoor fan:

The indoor fan's speed can be chosen in automatic,high,mid,low condition;and runs at super high wind, high wind, mid wind or low wind speed.

you could set the high wind, mid wind, low wind and automatic wind to run in the heating mode.

in the heating mode,the relation curve about the indoor fan and the indoor coil pipe temperature (T_p) as follows:

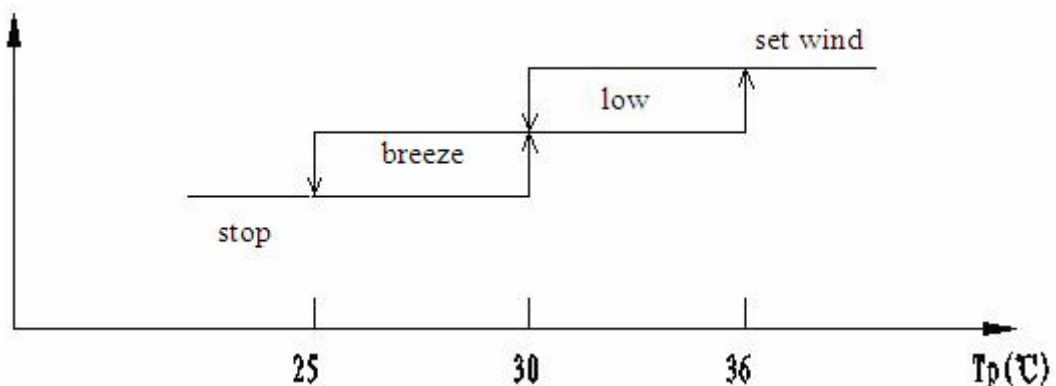

Chart 2-5

NOTE: when T_p is less than 30 and the external air flap is in the anti cold wind angle, the indoor fan blows Slightly wind.

a) Indoor coil temperature rise from 25 °C to 30 °C process, the indoor fan blows tiny wind.

- b) Indoor coil temperature reduces from 30 °C to 25 °C process, the indoor fan blows low wind.
- c) when T_p is greater than or equal to 30 ,the indoor fan blows low wind and quit the anti cold wind state, this moment, the external air flap returns to the condition before the anti cold wind.

when T_p is less than 25 , the indoor fan stops running; when T_p is greater than or equal to 25 , the air flap enters the anti cold condition, until T_p is greater than or equal to 30 , quits the anti cold wind state.

when the compressor stops running, the air flap is in the anti cold condition, the indoor fan blows tiny wind, satisfy .

the indoor fan's operation of curve as follows when set to automatic wind in the heating mode:

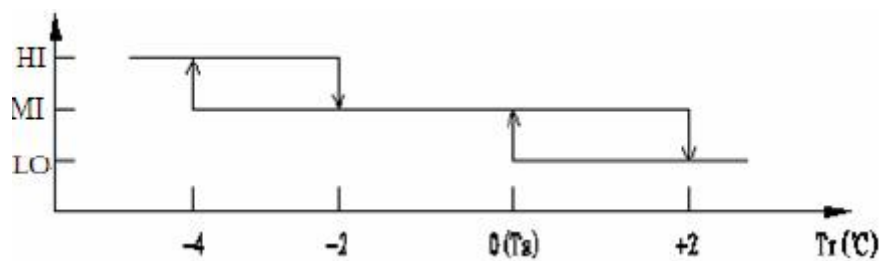

Chart 2-6

NOTE: Until conditions (2) meets the conditions (3) can run by the above curve.

6. anti cold wind function: the heating mode light flashes by 1 Hz way in anti cold wind mode. if this style has not the heating mode icon, the running light will flash at 1 Hz way.
7. blow the remaining heat function:turn off the unit with remote controller or emergency switch button, the indoor fan will time lag 30 seconds to turn off, meanwhile the remaining heat is blowed to the room. The indoor pendulum do time lag 35 seconds to shut down.
8. working condition of the outdoor fan: except that it runs at defrost in defrost mode, others are the same with the cooling mode.
9. working condition of the four-way valve:
 - (1) the four-way is open at all the time in the defrosting condition.
 - (2) when the unit enters the defrosting condition, the four-way valve satisfies the defrosting work requirements.
 - (3) when heating mode conversion to cooling, dehumidification or ventilation mode, or the unit turns off in the heating mode, until the compressor shuts down for 2 minutes, the four-way turns off, except defrosting mode.
10. operating condition of the air flap:

(1) confirm the air flap's full open position is Pch1, and the full closed position is Pch2.

(a) when the unit is electrified, firstly, the air flap opens to Pch1 position and then back to Pch2 position.

(b) turning off the unit, firstly, the air flap opens to Pch1 position and then back to Pch2 position.

(c) turning on the unit, firstly, the air flap returns to Pch1 position and then normally runs.

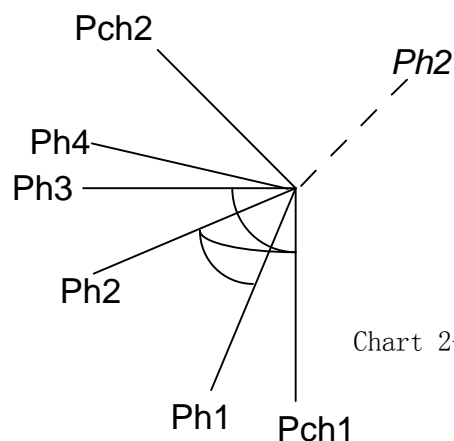

Chart 2-7

(2) when the compressor stops in heating mode, and the unit is in the anti cold wind or defrosting condition, the air flap is in the position Ph4. When the system quits the anti cold wind condition, the air flap returns to the position before preventing cold wind.

(3) working condition on fixed wind in heating mode:

(a) if the unit is electrified at the first, the condition is set fixed wind when turning on the unit, and firstly, the air flap opened to Pch1, and then stop to Ph2 position of the fixed wind. If no electrified at the first, the air flap stops the last memory position.

(b) in the swing wind or natural wind, if it is transformed to fixed wind, the air flap will directly stop the current running position.

(4) working condition of the swinging wind in heating mode:

(a) the air flap's starting point position is Ph1 in the swinging wind condition.

(b) the air flap firstly back to full open position Pch1 and then work at the swing wind way from the fixed wind or natural wind to swing wind.

(c) The air flap swings to go back and forth between Ph1 and Ph3 in swing wind condition.

(5) the natural wind is achieved when the wind pendulum swings two circles and stops 30 seconds in the swing wind condition, at the moment the air flap stops the starting position.

the external air flap's position is defined as follow table 2-5:

Table 2-5

Full open	Full close	Fixed wind	Swing wind starting point	Swing wind destination	Anti cold wind
Pch1	Pch2	Ph2	Ph1	Ph3	Ph4

NOTE:(1) Pch1.Pch2.Ph1~Ph4 are programmable dates that are stored in indoor EEPROM.

(2) broken line“Ph2” is the position where the M kernel fixed wind.

11. when the units operate in heating mode, the units have the relevant protection to the indoor coil pipe

preventing frostbite, the outdoor exhaust temperature overheating protection, overcurrent protection, low-voltage protection, the compressor overheating protection, indoor fan fault protection, sensor fault protection, system fault protection, IPM fault protection, communications fault protection, 3 minutes time lag protection of the compressor and so on, please see details in Indoor general protection function and outdoor software functions and specifications.

12. defrosting function: please see the outdoor software functions specifications.

3.2.5 ventilation mode

1. the range to setting temperature:16 -32

2. working condition of the compressor:

Compressor is closed all the time in the ventilation mode.

3. outdoor fan working condition:

Outdoor fan is closed all the time in the ventilation mode.

4. working condition of indoor fan:

In ventilation mode,indoor fan running is the same with that in cooling.

5. working condition of the four-way valve:

The four-way valve is closed all the time in the ventilation mode.

6. working condition of the external air flap:

In ventilation mode, the external air flap runs at the same with that in cooling.

7. there aren't the blowing remain cool and heat functions in the ventilation mode. The indoor fan directly turned off when the unit is turned off, so does the wind pendulum.

3.2.6 mode conflict definition

mode conflict is applied to DC Inverter Multi-Split Air-Conditioner Unit, its definition is as follows:

1. ventilation mode doesn't conflict with any modes, but cooling (dehumidification) and heating exist mode conflict;

2. if one unit is the cooling or dehumidification condition,the other plans to run heating mode, the unit which runs heating mode displays mode conflict "dI", Vice versa;

3. when the mode conflict is appeared, the unit displays malfunction code, and the indoor fan will run at setting wind speed in cooling mode, or it will stop running in heating mode.

3.2.7 sleeping function

1. press button of "sleep", air-conditioners will in the state of sleep. Fan of indoor is running with low winds, then click "sleep" button, and then will cancel "sleep", resume previous running state .close unit if press "on / off" button, at the same time cancel the sleep settings.

2. after setting sleep by remote 5s, display screen only display logo of “sleep” or the light of running and sleep is light, other logo is close. That is the sleep close screen.

(1) For multicolored screen only logo of sleep is light when in the state of sleep;

(2) For Nixie tube and LED light: the light of running and sleep is light, other logo is close.

Note: during the sleep operation, if the unit receives the timing time that has been adjusted, the twinkling of the 8LED on the display screen means that the status is being revised, if the unit receives that the set temperature has been adjusted, the 8LED will be directly lighten, the air conditioning will be adjusted to the operation status the same as the status before the sleep during the changing status, it will be closed if there is not any change in five seconds.

3. When the sleep is set at the refrigerating mode, the temperature is T_{s+1} after one hour, T_{e+2} after two hours, and then retain constant after this..

4. When the sleep is set at the heating mode, the temperature is T_{s-1} after one hour, T_{s-3} after two hours, T_{s-5} after three hours, and then retain constant after this..

5. When the sleep is set at the dehumidification mode, it still operates as the dehumidification mode; only the sleeping screen off is carried out..

6. When the sleep is set at the ventilation mode, the temperature setting is not adjusted; only the sleeping screen off is carried out..

7. When the sleep is set at the auto mode, the sleep function runs at the time of the sleep is set according to the corresponding mode which the auto mode enters into.

8. Under the sleep mode, the default of the indoor fan speed is low wind, but it can be adjusted according to the remote control signal of the users (except the dehumidification mode).

9. sleeping function and turbo function can't run at the same time,namely when turbo function runs, the sleeping function can't run,vice versa.

3.2.8 high-efficiency mode (economy)

(1) when press the “ECONO” button on the remote controller,the system enters high-efficiency mode,the indoor will run at high winds , and the wind speed is adjustable;press “ECONO” button again, the system can exit the high-efficiency mode;

(2) Compressor objective frequency is intermediate frequency test frequency of the corresponding modes, all various protections are effective under high—efficiency mode;

(3) the system doesn't run this function in starting default status, after conversion mode, automatically cancelled this function.

3.2.9 Three-dimensional air function (support the style with tridimensional air pendulum)

(1) Three-dimensional air: the internal air door swings the wind from up to down and from right to left in the start-up condition matching with the external air door..

(2) Operation condition of the internal air door: the working angle range of the air flap is defined between 0°and 120° as one cycle.

(3) When power on for the first time, the internal air flap will swing to one side firstly and return back the middle position.

(4) During start-up, the original air flap is set in the middle position.

(5) Pressing the “wind direction” button, the internal air door will switch in the method of swing --- stop..

(6) The air flap works repeatedly between 1 and 2 during swing.

(7) Under the swing condition, pressing the “wind direction”, the internal air door will stop directly at current position..

remark: 1 is the swing wind starting point angle of internal air flap, 2 is the swing wind destination angle of internal air flap, and they are stored in indoor EEPROM.

Turbo function

The turbo function is only applicable in the cooling and heating modes, when the remote control enters into the turbo, the indoor fan is super high wind, and the compressor is operating at the maximum frequency at present;

(1) When pressing the “turbo” button of the remote controller, the remote controller will switch circularly as “turbo” “cancel” “turbo”; when receiving the signal of the turbo button on the remote controller, the indoor “turbo lamp” will lighted immediately (when there is the “turbo lamp” on the display lamp board).

(2) During the turbo operation, the compressor will operate at the current allowable maximum frequency point; the wind speed of the air conditioner is set at the “super high wind”, at this moment, the wind speed on the remote controller although can be set, but it is ineffective for the air conditioner;

(3) During the turbo operation, the user can set the operating status with pressing other buttons (except on/off and modes), the air conditioner will not refresh the turbo operating time any more when receiving the turbo code;

(4) Ending conditions of the turbo operation:

a) When the operating time is longer than 20 minutes, the turbo operation will be cancelled automatically..

b) Cancel with the turbo button of the remote controller.

(5) It will operate according to the corresponding work frequency of cooling/heating when the turbo is automatically cancelled, while it will operate according to the setting mode of the remote controller when cancelled in the method of remote control.

(6) The turbo operation can be set under the status of timing turn-on, when it is the time of the fixed time, the turbo method will start running..

(7) During the turbo operation, all conditions of limitation and protection will act.

Auxiliary function

3.3 Self- check function

(1) the indoor unit possesses self-checking function. firstly press the emergency switch button ,and then switch on the power supply, thus enter the self-check state, all the delivery outlets output the relevant information in turn:

Model code (0.5S) —the running lamp brighten (0.5S) —the timing lamp brighten (0.5S) —the turbo lamp brighten (0.5S) —the economical operation lamp brighten (0.5S) —the high bit of the digital tubes all brighten (0.5S) —the low bit of the digital tubes all brighten (0.5S) —the indoor fan starts (time lag 0.5s) - power supply outputs (outdoor relay electrifies for 0.5S) —the buzzer sends 1 sound like “di” (time lag 0.5S) —the buzzer sends the second sound and shows to end all the exports.

Remark: different types vary due to the difference between display lamp boards; the LED lamps and digital tubes will be lightened according to corresponding display.

(2) in self-check status, the external air flap runs at closing motion, and the internal air flap operates at swing wind way.

(3) when the indoor fan starts, “the running lamp ”indicates the indoor fan’s feedback condition. If the running lamp flickers, it shows the feedback signal, or else absence of feedback; quick twinkle shows the indoor fan runs at quick speed, or else low speed.

(4) model code: “25” stands for 25GW, “35” stands for 35GW, the rest may be deduced by analogy.

3.4 Power-off memory function

EEPROM stores the running parameter before the air conditioner is shut down, after power on again, the air condition will return to the running status before power down.

(1) when the unit receives the correct remote control code in the starting up or standby status, the effective control code and data validation are checked and wrote in the designated unit EEPROM..

(2) when turn on or turn off the unit with the emergency switch button,or press any buttons to set the air conditioner the relevant condition, thus the operation results will be key to control code written into the specified unit of EEPROM.

(3) timing time is renovated and stored in EEPROM every one hour, electrify again after power cut, the unit will run according to the timing time stored before power cut.

(4) because the sleeping function has not the operation timing turning off the unit, when have set the sleeping function, electrify again after power cut, the system will choose to turn on the unit, meanwhile doesn't memory sleeping function any more; shut down the unit because of malfunction, electrify again after power cut, the system will select turning on the unit .

(5) power-off memory only memories the operating mode, but don't remember these auxiliary functions like turbo, highly efficiency, sleeping function and so on .

3.5 Emergency switch function

Press the emergency switch button in the starting condition, the unit is shut down; vice versa, and its setting temp. is permitted to be 25°C. Press the emergency switch button every time, the buzzer sends one time sound.

3.6 Sound,light prompt function

(1) the controller possesses the buzzer. When it receives the order of the remote controller, and the system electrifies or shut down in the starting condition, the buzzer will send one “di” sound.

(2) when the system appears the malfunction, the nixietube or LED indicate the relevant fault or protection code.

(3) when Air Conditioning System is DC inverter Multi-Split Air-Conditioner Unit, if the indoor unit and outdoor unit appear the mode conflict, the indoor double 8 nixietube will display ”DI”.

display shutting screen function (support the model with this function)

(1) when the air conditioner is starting, pressing the “LAMP” button on remote controller enter the display shutting screen function condition, shut all the indicator on the display lamp panel; press it again can exit the display shutting screen function, the display lamp panel display original status.

(2) when the unit receives the remote controller signal in the display shutting screen condition, the display lamp panel will show at the setting requirement, and then all the display lamp are shut after 10s.

(3) the system doesn't run this function in starting default status, after conversion mode automatically cancelled this function.

3.7 outdoor defrosting electrical heat tape function (support the model with this function)

When the ambient temperature is less 0°C, the system will start the outdoor defrosting electrical heat tape function.

4. Indoor common malfunction / protection function

4.1 sensor malfunction protection

1. when indoor ambient temp. sensor and outdoor temp. sensor are short circuit or open circuit, the unit displays malfunction code, the total units stop running;

2. when inlet and outlet temp. sensor of indoor evaporator appears malfunction for DC inverter single-split series, the unit runs with fault and sends the middle part of indoor coil temperature to outdoor unit;

3. when inlet and outlet temp. sensor of indoor evaporator appears malfunction for DC Inverter Multi-Split Air-Conditioner Unit, the current indoor unit will shut down and display the relevant malfunction code.

4.2 communication error protection

If the communication is abnormal for continuous 3min, the system will stop the compressor and display the relevant malfunction code. When the communication is normal and fault code disappears for 1 minute, the system will automatically start.

4.3 PG motor protection function

If the system checks the PG motor has not the feedback signal for continuous 20 seconds in the PG motor running, the PG motor will enter the running within fault; if the system checks the speed of PG motor is lower than 200rpm for continuous 60 seconds, thus the system considers PG motor faulty, and then the total units stop running and report the relevant malfunction code.

The following is the setting motor speed during operation within fault:

- (1) the system will break-over controlled silicon after zero passage 1mS in the high wind;
- (2) the system will break-over controlled silicon after zero passage 2mS in the mid wind;
- (3) the system will break-over controlled silicon after zero passage 2.5mS in the low wind;
- (4) the system will break-over controlled silicon after zero passage 3mS in the slightly wind;

if the feedback signal returns to be normal during PG motor operation within fault, the PG motor still runs within fault, until the system starts again next time.

remark: there is not PG motor protection function in producing self-check.

4.4 indoor coil pipe antifreeze protection in cooling

- (1) when indoor coil pipe temperature is less than 6 in cooling, the compressor doesn't run.
- (2) when indoor coil pipe temperature is less than 1 , the system stops compressor and displays indoor coil pipe overcooling/overheating protecting code;
- (3) when indoor coil pipe temperature is less than 3 , the compressor's frequency will drop, until lowest running frequency, thus the compressor stops running and the system displays indoor coil pipe overcooling/ overheating protecting code;
- (4) when indoor coil pipe temperature is greater than or equal to 3 , but is less than 6 , compressor frequency forbids rising;
- (5) when indoor coil pipe temperature is greater than or equal to 6 , the system runs normally;

(7)after this protection code appears for 1 minute, the system could start automatically.

4.5 indoor coil pipe overheating protection in heating

(1) when indoor coil pipe temperature is greater than or equal to 48 in heating,the compressor doesn't run;

(2) when indoor coil pipe temperature is greater than or equal to 73 , the compressor stops running and the system displays indoor coil pipe overcooling/overheating protecting code;

(3) when indoor coil pipe temperature is greater than or equal to 63 , the compressor's frequency will drop, until lowest running frequency,thus the compressor stops running and the system displays indoor coil pipe overcooling/ overheating protecting code ;

(4) when indoor coil pipe temperature is greater than or equal to 52 , but is less than 63 , compressor frequency forbids rising;

(5) when indoor coil pipe temperature is less than 52 , the system runs normally;

(6) after this protection code appears for 1 minute, the system could start automatically.

4.6 system lacking refrigerant or 4-way valve fault

(1) during cooling:

After the compressor has operated for five minutes (which has been set in the EEPROM), if the temperature of the indoor coil can not be 5 lower than the room temperature, the indoor fan will automatically turns to the breeze operation, 13 minutes later, if above requirements can not been met with, the compressor will be stopped to display the fault code; it can only operate again after switching off..

(2) during heating:

When the temperature of the indoor coil is lower than 20 (which is set in the EEPROM) for 20 minutes, the compressor will be stopped to display the fault code; it can only operate again after switching off.

The system fault can only be determined within 20 minutes after the compressor is switched on, after that the faults will not be determined. After stopping in remote controlling or emergency or power off, the system fault should be determined within 20 minutes after starting on again. After the system fault occurs, the indoor fan will not work, and the flap will not be closed..

Appendix :malfunction and protection display

1. Indoor fault and protection explanation

(1) when the indoor unit has not the nixietube, the malfunction and protection can display by LED lamp: firstly light 3 seconds, then flicker n at 1Hz,looping execution;

(2)when the indoor unit has the nixietube:

a) the nixietube shows “dF” code in defrosting;

b) under normal circumstances, the nixietube only shows the latest malfunction code or protection

code;

(3) when malfunction and protection exist at the same time, the unit will shut down, but the system is priority to showing malfunction code.

Appendix : display lamp panel

Note:when the system electrifies at first time,all the patterns on display lamp panel and LED lamp all lighten,and extinguish after 2s.

Display modes

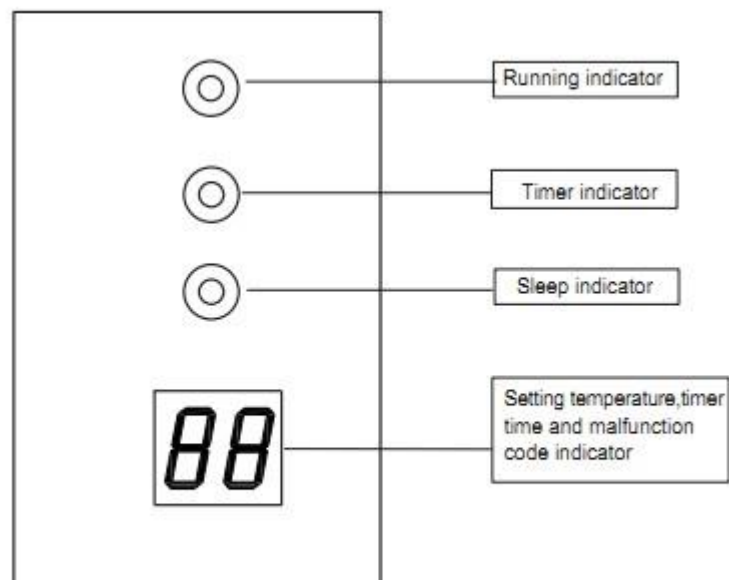

2. Indoor unit fault display table

Check parts	Serial number	Malfunction content	Indoor unit display status		
			nixietube	LED (indoor unit without the nixietube)	
				Running lamp Flashing frequency n	Timing lamp Flashing frequency n
Indoor parts	1	The communication faults in the indoor and outdoor units	F1	1	Lighten
	2	Indoor ambient temp. sensor fault	F2	2	Lighten
	3	Indoor coil temp. sensor fault (include:inlet.middle of pipe.outlet)	F3	3	Lighten
	4	Indoor fan fault	F4	4	Lighten
Outdoor parts	1	Outdoor module fault	F5	5	Lighten
	2	Outdoor ambient temp. sensor fault	F6	6	Lighten
	3	Outdoor coil temp. sensor fault	F7	7	Lighten
	5	compressor discharge temp. sensor fault	F9	9	Lighten
	7	compressor drive abnormal fault	FC	11	Lighten
	10	Others fault	FF	14	Lighten

3. Indoor unit protection display table

Check parts	Serial number	Protection content	Indoor unit display status		
			nixietube	LED (indoor unit without the nixietube)	
				Running lamp Flashing frequency n	Timing lamp Flashing frequency n
Indoor parts	1	Evaporator temp. protection	P1	Lighten	1
Outdoor parts	1	overheat, over current protection of inverter module	P2	Lighten	2
	2	over current protection	P3	Lighten	3
	3	Compressor discharging temp. protection	P4	Lighten	4
	4	over heat of compressor top protection	P5	Lighten	5

	6	power supply over current / over voltage protection	P7	Lighten	7
	9	high temp. of condenser protection	PA	Lighten	10
	10	high temp. of outdoor ambient protection	PC	Lighten	11

Explanations for each error are introduced as below:

A、 The communication faults in the indoor and outdoor units: F1

Descriptions for preconditions, actions, and elimination conditions:

(1) Protection Preconditions: For a constant 3mins, no data's got from the indoor unit or no communicational data's got from the outdoor unit.

(2) Protection Actions: The compressor shuts down, the indoor digital tube shows F1, and the outdoor LED flickers 15 times at 1 HZ.

(3) Elimination conditions: The communication data becomes normal, and after the error disappeared for 1min, the model can restart automatically.

Main causes: The wires between the indoor and outdoor units are misconnected, the communication line is loose, or the voltage regulator is broken. If all above reasons are OK, please directly replace the outdoor PCB.

Checking methods:

- 1: Check whether the connection of the indoor and outdoor units is correct. If not, please adjust and confirm again.
- 2: Check whether the inserter part of the PCB is loose, if it is, please fix and confirm again.
3. check whether the alternating current(voltage) of the outdoor PCB is normal, or whether the fuse is loosened or blew out.

The brown and the blue line voltage is AC220V

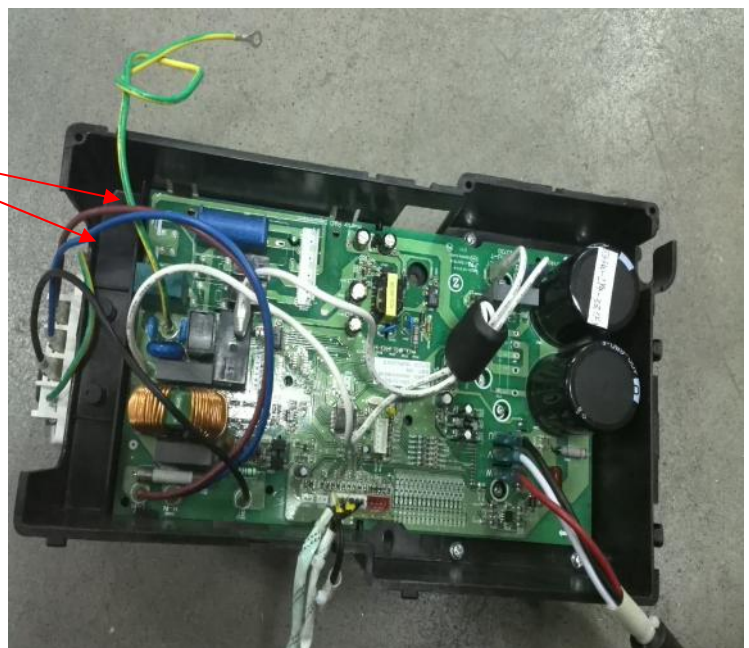

(the input voltage of the outdoor terminal)

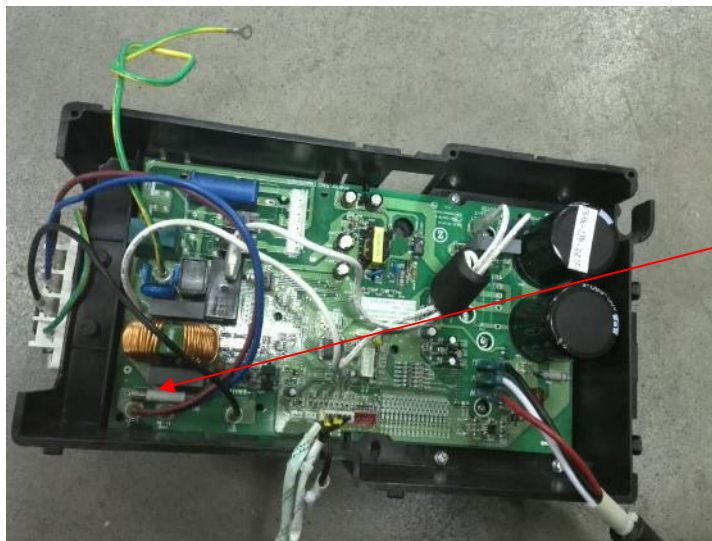

The fuse

(the fuse can be gotten through under the normal situation. Change the fuse if it is open circuit.)

4: With the DC pattern of the multimeter, please measure whether the voltage between the terminals S and N is 3-16V, if it's out of the range, please cut off the diode (30V) and test again. If the voltage keeps abnormal, replace the outdoor main board.

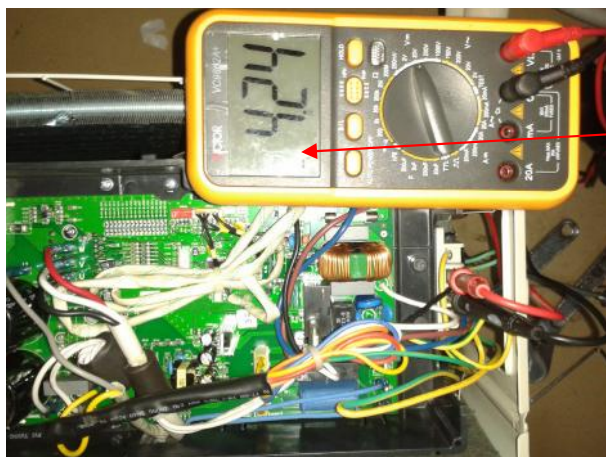

Normally, the voltage ranges from 3V to 18V.

5. check whether the voltage of the DC PN is normal. The normal voltage should be around 310V.

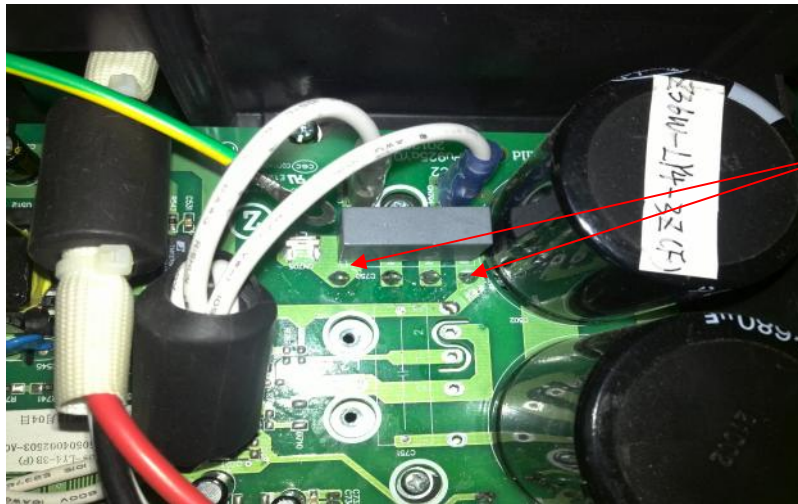

The two point voltage is DC310V

(the output voltage of the Bridge rectifier)

6. check whether the electrolytic capacitor is convex or burned out.

Cracking and Convex

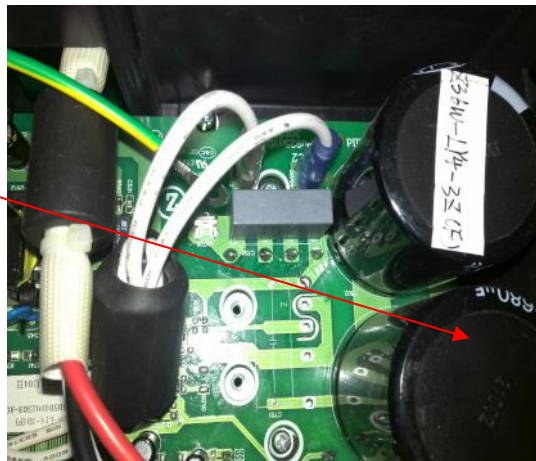

7. check whether the 7805 is damaged

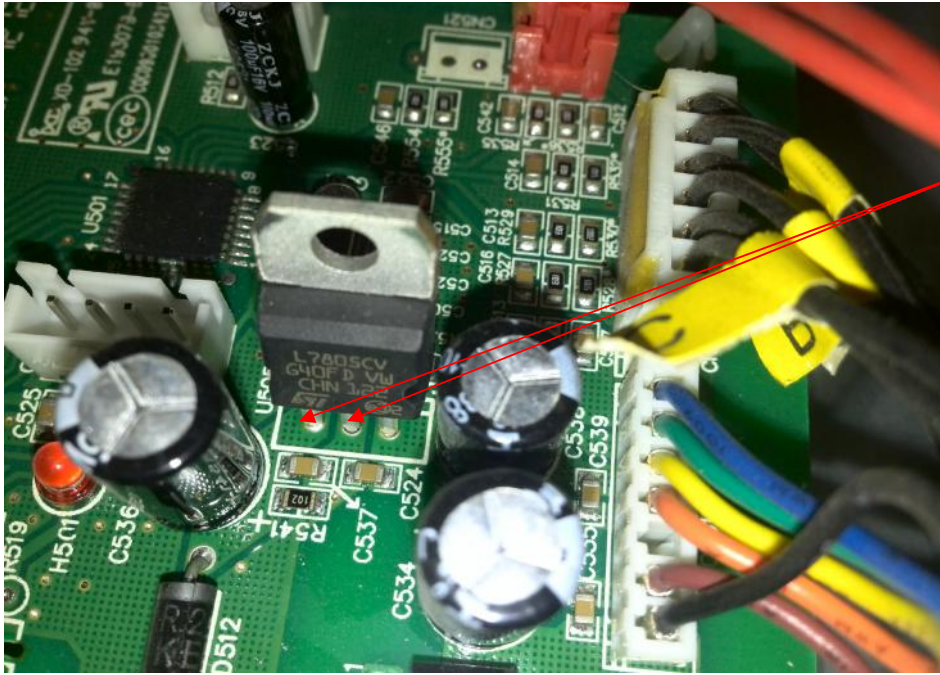

The two point voltage is DC5V

8. check whether the relative electronic components are burned out or loose weld by eyeballing.
9. If the above procedures cannot solve the problem, please change the outdoor whole set of the electric control boards.

B. Indoor ambient temp. sensor fault: F2

Main causes: The sensor wire is loose or bad contacted, or the temp sensor is damaged. When make sure the sensor is OK, please check whether the corresponding integrity circuit has any components missing or damaged.

Checking methods:

1. Check whether the temp sensor wire is well contacted, if loose, please fix and confirm again.
2. Remove the temp sensor and check whether its resistance is OK. If there's any open-circuit, short-circuit, or the resistance value is abnormal, the sensor must be damaged and should be replaced.
3. Heating/cooling the temp sensor and check whether its resistance changes. If no variation or the variation doesn't follow the rules, please replace.
4. If all above mentioned are OK, please replace the indoor PCB.

C. Indoor coil temp. sensor fault (include: inlet. middle of pipe. outlet) : F3

Main causes: The sensor wire is loose or bad contacted, or the temp sensor is broken. When make sure the sensor is ok, please check whether the corresponding integrity circuit has any components missing or damaged.

Checking methods:

1. Check whether the sensor wire is loose, if so, please repair.
2. Remove the temp sensor and check whether its resistance is OK. If there's any open-circuit,

short-circuit, or the resistance value is abnormal, the sensor must be damaged and should be replaced.

3. Heating/cooling down the temp sensor and check whether its resistance changes. If no variation or the variation doesn't follow the rules, please replace.

4. If all above mentioned are OK, please replace the indoor PCB.

D、 Indoor fan fault: F4

Main causes: No feedback pulse signal's come from the indoor fan. After 30s, the indoor displayer shows F4 and the indoor fan stops.

Checking methods:

1. Power on and start the unit, check whether the indoor corresponding terminal has output voltage.

If not, replace the indoor PCB.

2. Remove the indoor fan motor terminal and check whether the resistance of the winding is normal.

If not, replace the fan motor.

3. If all above mentioned are ok, please replace the indoor PCB.

E、 Outdoor module fault: F5

Main causes: The key point is to check the outdoor PCB and the drive circuit. For some outdoor units, the outdoor main board and the drive module are separated. In this case, please firstly check whether the connection (6 cores) between them is well contacted.

Checking methods:

1、 Check whether the connection between the main board and the drive module is well contacted, if not, repair it.

2、 If the main board is OK, replace the outdoor drive board.

F、 Outdoor ambient temp. sensor fault: F6

Fault preconditions, actions and elimination conditions;

(1) Protection preconditions: Outdoor ambient temp >55 or <-20 .

(2) Protection actions: The compressor shuts down and the indoor digital tube shows F6.

(3) Elimination conditions: $-20 < \text{The outdoor ambient temp} < 55$

Checking methods:

1. Check whether the sensor wire is loose, if so, please repair.

2. Remove the temp sensor and check whether its resistance is OK. If there's any open-circuit, short-circuit, or the resistance value is abnormal, the sensor must be damaged and should be replaced.

3. Heating/cooling down the temp sensor and check whether its resistance changes. If no variation or the variation doesn't follow the rules, please replace.

4. If all above mentioned are OK, please replace the outdoor PCB.

G、 Outdoor coil temp. sensor fault: F7

Fault preconditions, actions and solutions;

- (1) Protection preconditions: The outdoor pipe temp 54 or -20
- (2) Protection actions: The compressor shuts down and the indoor digital tube shows F7.

Checking methods:

1. Check whether the sensor wire is loose, if so, please repair.
2. Remove the temp sensor and check whether its resistance is OK. If there's any open-circuit, short-circuit, or the resistance value is abnormal, the sensor must be damaged and should be replaced.
3. Heating/cooling down the temp sensor and check whether its resistance changes. If no variation or the variation doesn't follow the rules, please replace.
4. When make sure the sensor is ok, please check whether the corresponding integrity circuit has any components missing or damaged, please replace if there's any case.

H. Compressor discharge temp. sensor fault: F9

Fault preconditions, actions and solutions:

- (1) Protection precondition: The compressor discharge temp >120 or <0 .
- (2) Protection actions: The compressor shuts down and the indoor digital tube shows F9.

Checking methods:

1. Check whether the sensor wire is loose, if so, please repair.
2. Remove the temp sensor and check whether its resistance is OK. If there's any open-circuit, short-circuit, or the resistance value is abnormal, the sensor must be damaged and should be replaced.
3. Heating/cooling down the temp sensor and check whether its resistance changes. If no variation or the variation doesn't follow the rules, please replace.
4. When make sure the sensor is ok, please check whether the corresponding integrity circuit has any components missing or damaged, please replace if there's any case.

H、Compressor drive abnormal fault: FC

Fault preconditions, actions and elimination conditions:

- (1) Protection preconditions: The compressor fails to drive for a constant 5 times. Then it will restart but delay for 3mins. Meantime, it will count the failure times. If it fails again, it should delay for another 3mins and accumulate the times to the former data, then make a circle. Finally, the accumulation times are more than 3 times.
- (2) Protection actions: The compressor shuts down, the outdoor LED flickers 7 times at 1HZ, and the indoor digital tube shows FC.
- (3) Elimination conditions: The compressor can start normally.

Checking methods:

1. Check whether the connecting wire on the drive board is reliable. If not, please repair it and check again.
2. Check whether the screws on the drive board are well fixed (do not affect the heat dissipation). If not, fix them one by one.

[It should be well noted, when fixing, please control your force to prevent the module from being crushed.]

3. Check whether there's input voltage of the drive module. For example, whether the voltage between P and N is about 300V, whether there're 5V and 15V input voltage. If not, replace the controller directly. If yes, replace the drive module (For some types, the outdoor controller and the drive module are separated, if there's one board only, replace the whole board.)

If no connection between the compressor and the PCB, it will show FC.



I、 Others fault: FF

Checking methods:

1. Check whether the system is OK (Such as weld leakage or weld blockage problem), and check the pressure of the system to judge whether there's lack of refrigerant.
2. If the refrigerant is OK, please check whether the 4-way valve is damaged, replace it if needed.
3. If the system is OK and no lack of refrigerant, please replace the PCB.

Descriptions for the protection code are as below:

A、 Evaporator temp. protection: P1

Fault preconditions, actions and elimination conditions:

- (1) Protection preconditions: When cooling, the indoor pipe temp < -1 ; When heating, the indoor pipe temp > 63
- (2) Protection actions: The compressor shuts down and the indoor digital tube shows P1.
- (3) Elimination conditions: When cooling, the indoor pipe temp > 6 ; when heating, the indoor pipe temp < 49

Checking methods:

1. Power off and wait for 3mins, restart the unit to see whether the compressor can start normally.
2. Check whether the indoor coil pipe temp sensor is loose, if so, repair it and check again.
3. Remove the temp sensor and check whether its resistance is OK. If there's any open-circuit, short-circuit, or the resistance value is abnormal, the sensor must be damaged and should be replaced.

4. Heating/cooling down the temp sensor and check whether its resistance changes. If no variation or the variation doesn't follow the rules, please replace.
5. If step 2, 3, 4 are ok, replace the indoor PCB.

B. overheat, over current protection of inverter module: P2

Protection preconditions: When the current is larger than 10A and the module temp is overheat. The outdoor LED flickers 10 times at 1HZ and the indoor digital tube shows P2.

Checking methods:

1. Check whether the connecting wire on the drive board is reliable. If not, please repair it and check again.
2. Check whether the module and the radiator are firmly contacted. If loose, please fix it to prevent the bad heat dissipation and burn down the module.
3. If they are well contacted and the heat dissipation is perfect, but there still shows P2, please replace the module directly. (PS: If there's one board only, replace the whole board.)

C. over current protection: P3

Fault preconditions, actions and elimination conditions:

(1) Protection precondition: The current is larger than the overload value (wall spilt type: 10A, floor standing type: 25A) and lasts for 5s.

(2) Protection actions: The compressor shuts down, the outdoor LED flickers 11 times at 1HZ and the indoor digital tube shows P3.

(3) Elimination conditions: Having been shut down for 3mins, the current becomes lower than the overload value.

- When $10A > \text{total current} > 8.5A$, the running frequency of the compressor decreases to 35HZ, but the current still larger than 8.5A, it will show over current fault.
- When $8.5A > \text{total current} > 7.5A$, the compressor stays in the frequency-increasing forbidding area.
- When $\text{total current} < 7.5A$, the compressor enters into the normal working area.

Checking methods:

1. Check whether the power supply in the user's home is normal. If not, explain to the user.
2. Restart the unit to see whether the compressor can work. If yes, the current is larger by accident, it's the result due to the A/C's self-protection. Please explain to the user. If cuts down the power then power on and restart the unit, the error still there, please replace the outdoor drive module.

D. Compressor discharging temp. protection: P4

Fault preconditions, actions and elimination conditions:

(1) Protection Preconditions: The discharge temp of the compressor > 110 and lasts for 20s

(2) Protection actions: The compressor shuts down, the outdoor LED flickers 12 times at 1HZ and the indoor displayer shows P4.

(3) Elimination conditions: When the discharge temp decreases to 90 or lower

Checking methods:

1. Power off and wait for 3mins, then restart the units to see whether the compressor can start.
2. If the compressor cannot start, check whether the temp sensor wire is loose. If loose, fix it.
3. Remove the temp sensor to test its resistance, if it's not consistent with the normal value, the sensor is damaged and should be replaced. If the sensor is OK, replace the outdoor PCB.
4. If the compressor can start, judge whether it belongs to the above mentioned preconditions, if yes, the protection is OK. Then check whether it's lack of refrigerant and charge some if needed. If the system shouldn't have acted the protection, please make sure the temp sensor is OK.

C、 over heat of compressor top protection : P5

Fault preconditions, actions and elimination conditions:

(1) Protection preconditions: The compressor top protector is overheat(>120) and the switch is disconnected.

(2) Protection actions: The compressor shuts down, the outdoor LED flickers 13 times at 1HZ and the indoor digital tube shows P5.

(3) Elimination conditions: The temp of the compressor top protector decreases down (< 105) and the switch is reconnected.

Checking methods:

1. Power off, disconnecting the compressor wire from the PCB, check whether the protector terminals are open-circuit. If open-circuit, the top protector is damaged and should be replaced. If short-circuit, the protector is OK.
2. Check whether the temp's getting higher due to lack of refrigerant, if so, charge enough refrigerant. If not, replace the outdoor PCB.

D、 power supply over current / over voltage protection: P7

Fault preconditions, actions and elimination conditions:

(1) Protection preconditions: The AC voltage $>265V$ or $< 170V$.

(2) Protection actions: The compressor shuts down, the outdoor LED flickers 15 times at 1HZ and the indoor digital tube shows P7.

(3) Elimination conditions: $175V < \text{The AC voltage} < 250V$

Checking methods:

1. Power on and start the units, keep measuring the input AC voltage of the terminal board to see whether the voltage is within the working range. If not, the voltage of the user's home must be outside the proper range.
2. If the voltage is normal, replace the outdoor drive module.

E、 high temp. of condenser protection: PA

Fault preconditions, actions and elimination conditions:

(1) Protection preconditions: The outdoor pipe temp >63 .

(2) Protection actions: The compressor shuts down, the outdoor LED flickers 18 times at 1HZ and the indoor digital tube shows PA.

(3) Elimination Conditions: The outdoor pipe temp <48 .

Checking methods:

1. Power off and wait for 3mins, then restart the units to see whether the compressor can start normally.
2. Check whether the outdoor coil pipe temp sensor is loose, if so, fix it.
3. Remove the temp sensor and check whether its resistance is OK. If there's any open-circuit, short-circuit, or the resistance value is abnormal, the sensor must be damaged and should be replaced.
4. Heating/cooling down the temp sensor and check whether its resistance changes. If no variation or the variation doesn't follow the rules, please replace.
5. Check whether the outdoor motor works slow or doesn't work. If it's ok, replace the indoor PCB.

If there's no connection between the outdoor motor and the PCB, the displayer will show PA.



F、 high temp. of outdoor ambient protection: PC

Fault preconditions, actions and elimination conditions:

(1) Protection preconditions: When cooling, the outdoor ambient temp ≤ 8 ; when heating, the outdoor ambient temp ≥ 34 , the compressor can not start.

(2) Protection actions: The compressor shuts down, the outdoor LED flickers 19 times at 1HZ and the indoor digital tube shows PC.

(3) Elimination conditions: When cooling, the outdoor ambient temp > 8 ; when heating, the outdoor ambient temp < 34 , the compressor can start.

Checking methods:

1. Check whether the outdoor ambient temp is too low (or too high), so the compressor fails to start.
2. When the ambient temp doesn't exceed the normal range, then check whether the outdoor ambient temp sensor is damaged, if so, replace it.

Common contrast table for the temperature of the sensor and the value of the resistance(3274)

Temperature °c	Resistance Min (K Ω)	Standard (K Ω)	Resistance Max (K Ω)	Value of the voltage 5V、 4.3K		Temperature °c	Resistance Min (K Ω)	Standard (K Ω)	Resistance Max (K Ω)	Value of the voltage 5V、 4.3K	
				Drop down	Pull up					Drop down	Pull up

-30	51.195	52.840	54.521	0.38	4.62	26	4.771	4.821	4.871	2.36	2.64
-29	48.659	50.232	51.805	0.39	4.61	27	4.599	4.649	4.699	2.40	2.60
-28	46.299	47.772	49.248	0.41	4.59	28	4.434	4.485	4.535	2.45	2.55
-27	44.071	45.452	46.832	0.43	4.57	29	4.277	4.327	4.377	2.49	2.51
-26	41.968	43.261	44.554	0.45	4.55	30	4.126	4.176	4.226	2.54	2.46
-25	39.981	41.193	42.405	0.47	4.53	31	3.981	4.031	4.081	2.58	2.42
-24	38.102	39.238	40.375	0.49	4.51	32	3.842	3.892	3.942	2.62	2.38
-23	36.326	37.391	38.457	0.52	4.48	33	3.709	3.759	3.808	2.67	2.34
-22	34.646	35.645	36.645	0.54	4.46	34	3.581	3.631	3.680	2.71	2.29
-21	33.055	33.993	34.931	0.56	4.44	35	3.495	3.508	3.557	2.77	2.23
-20	31.550	32.430	34.310	0.59	4.41	36	3.340	3.389	3.438	2.80	2.20
-19	30.097	30.923	31.748	0.61	4.39	37	3.226	3.275	3.323	2.84	2.16
-18	28.722	29.497	30.271	0.64	4.36	38	3.117	3.165	3.213	2.88	2.12
-17	27.420	28.147	28.873	0.66	4.34	39	3.012	3.06	3.107	2.92	2.08
-16	26.186	26.868	27.55	0.69	4.31	40	2.912	2.959	3.006	2.96	2.04
-15	25.017	25.657	26.297	0.72	4.28	41	2.815	2.861	2.908	3.00	2.00
-14	23.908	24.509	25.11	0.75	4.25	42	2.722	2.768	2.814	3.04	1.96
13	22.857	23.421	23.98	0.78	4.22	43	2.633	2.678	2.724	3.08	1.92
-12	21.859	22.389	22.918	0.81	4.19	44	2.547	2.529	2.637	3.12	1.88
-11	20.912	21.409	21.907	0.84	4.16	45	2.464	2.509	2.553	3.16	1.84
-10	20.013	20.48	20.917	0.87	4.13	46	2.385	2.429	2.473	3.20	1.80
-9	19.116	19.584	20.023	0.90	4.10	47	2.308	2.352	2.395	3.23	1.77
-8	18.322	18.734	19.146	0.93	4.07	48	2.235	2.278	2.231	3.27	1.73
-7	17.540	17.927	18.314	0.97	4.03	49	2.164	2.207	2.249	3.30	1.70
-6	16.797	17.160	17.524	1.00	4.00	50	2.096	2.138	2.180	3.34	1.66
-5	16.090	16.431	16.733	1.04	3.96	51	2.030	2.071	2.112	3.37	1.63
-4	15.418	15.739	16.060	1.07	3.93	52	1.966	2.006	2.047	3.41	1.59
-3	14.779	15.080	15.382	1.11	3.89	53	1.904	1.944	1.984	3.44	1.54
-2	14.170	14.454	14.737	1.15	3.85	54	1.844	1.884	1.923	3.48	1.52
-1	13.591	13.857	14.124	1.18	3.82	55	1.787	1.826	1.865	3.51	1.49
0	13.040	13.290	13.54	1.22	3.78	56	1.732	1.770	1.809	3.54	1.16
1	12.505	12.739	12.974	1.26	3.74	57	1.679	1.717	1.754	3.57	1.43
2	11.995	12.215	12.436	1.30	3.70	58	1.628	1.665	1.702	3.60	1.40
3	11.509	11.717	11.924	1.34	3.66	59	1.579	1.615	1.652	3.63	1.37
4	11.047	11.241	11.436	1.38	3.62	60	1.531	1.567	1.603	3.66	1.34
5	10.606	10.789	10.971	1.42	3.58	61	1.485	1.521	1.556	3.69	1.31
6	10.186	10.357	10.529	1.47	3.53	62	1.441	1.476	1.511	3.72	1.28
7	9.785	9.945	10.107	1.51	3.49	63	1.399	1.433	1.467	3.75	1.25
8	9.403	9.554	9.705	1.55	3.45	64	1.357	1.391	1.425	3.78	1.22
9	9.038	9.180	9.322	1.59	3.41	65	1.318	1.351	1.384	3.80	1.20
10	8.690	8.823	8.956	1.64	3.36	66	1.279	1.312	1.344	3.83	1.17
11	8.357	8.482	8.607	1.68	3.32	67	1.242	1.274	1.306	3.86	1.14
12	8.040	8.157	8.274	1.73	3.27	68	1.206	1.237	1.269	3.88	1.12
13	7.736	7.816	7.957	1.77	3.23	69	1.171	1.202	1.233	3.91	1.09
14	7.446	7.550	7.653	1.81	3.19	70	1.137	1.168	1.199	3.93	1.07
15	7.169	7.226	7.363	1.86	3.14	71	1.105	1.135	1.165	3.96	1.04
16	6.900	6.991	7.082	1.90	3.10	72	1.074	1.103	1.133	3.98	1.02
17	6.644	6.729	6.814	1.95	3.05	73	1.043	1.072	1.101	4.00	1.00
18	6.398	6.478	6.558	1.99	3.01	74	1.014	1.043	1.071	4.02	0.98
19	6.163	6.238	6.313	2.04	2.96	75	0.986	1.014	1.042	4.05	0.95
20	5.938	6.008	6.078	2.09	2.91	76	0.959	0.986	1.014	4.07	0.93

21	5.723	5.789	5.854	2.13	2.87	77	0.932	0.959	0.986	4.09	0.91
22	5.517	5.578	5.64	2.18	2.82	78	0.907	0.933	0.960	4.11	0.89
23	5.320	5.377	5.484	2.22	2.78	79	0.882	0.908	0.934	4.13	0.87
24	5.131	5.185	5.238	2.27	2.73	80	0.858	0.884	0.910	4.15	0.85
25	4.950	5	5.05	2.31	2.69	81					

**Contrast table for features of resistance and temp (R – T CONVERSION
TABLE)----Discharge sensor(3950)**

Contrast table for features of resistance and temp (R – T CONVERSION TABLE)----Discharge sensor
RB25B=50K Ω \pm 2% BB25/85 B=3950K \pm 2% (T/°C Rcen)

-40	1666.000	1	152.800	42	24.590	83	5.796
-39	1558.000	2	145.300	43	23.630	84	5.612
-38	1458.000	3	138.300	44	22.720	85	5.433
-37	1366.000	4	131.700	45	21.840	86	5.255
-36	1279.000	5	125.400	46	21.010	87	5.082
-35	1199.000	6	119.400	47	20.210	88	4.916
-34	1124.000	7	113.800	48	19.440	89	4.755
-33	1055.000	8	108.400	49	18.710	90	4.600
-32	989.900	9	103.400	50	18.010	91	4.451
-31	929.400	10	98.580	51	17.370	92	4.306
-30	873.000	11	94.040	52	16.750	93	4.167
-29	820.400	12	89.730	53	16.160	94	4.032
-28	771.300	13	85.640	54	15.590	95	3.902
-27	725.500	14	81.760	55	15.040	96	3.776
-26	682.700	15	78.080	56	14.520	97	3.655
-25	642.600	16	74.590	57	14.010	98	3.537
-24	605.200	17	71.270	58	13.520	99	3.424
-23	570.200	18	68.120	59	13.050	100	3.315
-22	537.400	19	65.120	60	12.600	101	3.209
-21	506.700	20	62.280	61	12.170	102	3.107
-20	477.900	21	59.570	62	11.750	103	3.009
-19	450.900	22	57.000	63	11.350	104	2.914
-18	425.600	23	54.550	64	10.960	105	2.822
-17	401.900	24	52.220	65	10.590	106	2.733
-16	379.600	25	50.000	66	10.230	107	2.647
-15	358.700	26	47.860	67	9.884	108	2.565

-14	339.100	27	45.830	68	9.551	109	2.484
-13	320.700	28	43.890	69	9.231	110	2.407
-12	303.500	29	42.040	70	8.922	111	2.332
-11	287.200	30	40.280	71	8.625	112	2.260
-10	271.900	31	38.610	72	8.339	113	2.190
-9	257.600	32	37.010	73	8.063	114	2.122
-8	244.100	33	35.490	74	7.797	115	2.057
-7	231.300	34	34.040	75	7.541	116	1.994
-6	219.400	35	32.660	76	7.294	117	1.933
-5	208.100	36	31.340	77	7.056	118	1.874
-4	197.400	37	30.080	78	6.826	119	1.817
-3	187.400	38	28.880	79	6.605	120	1.761
-2	178.000	39	27.730	80	6.329		
-1	169.100	40	26.630	81	6.186		
0	160.600	41	25.590	82	5.988		